

M6500-6550-6600 Series Spare Parts Manual

PANTUM

WWW.PANTUM.COM

M6500-M6550-M6600 Series

Monochrome Laser Printer



1 Components Summary

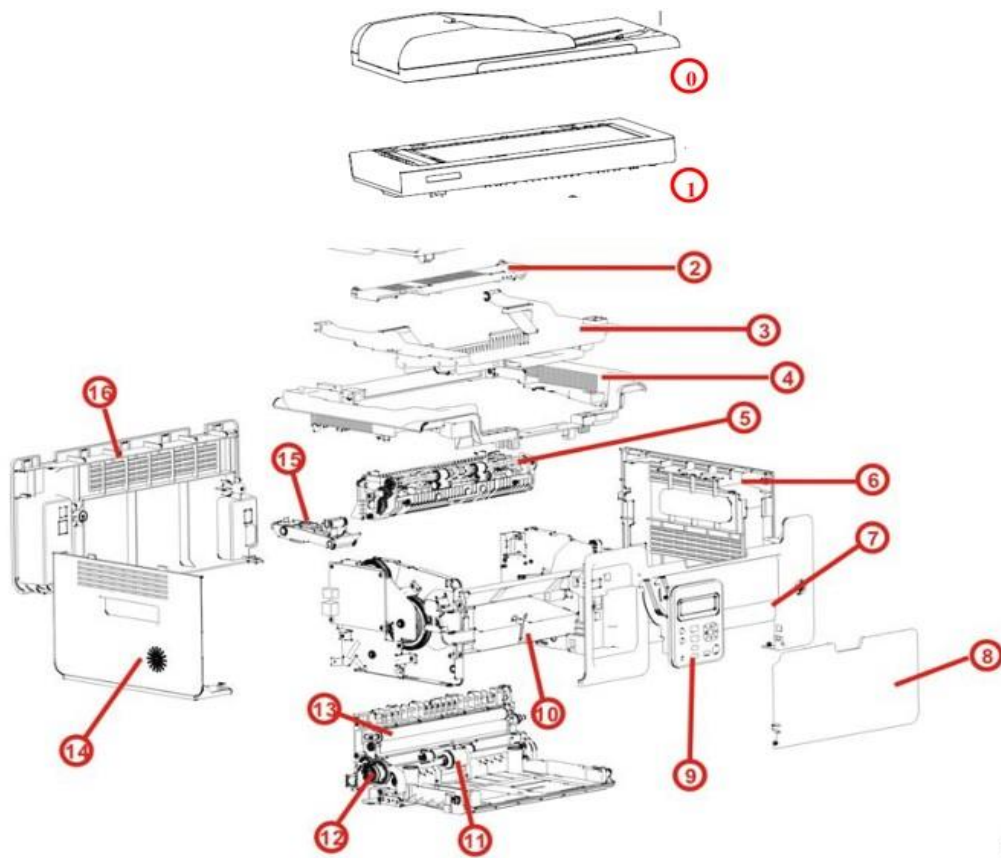





S/N	Name
0	Scanning platen (ADF)
1	Scanning components
2	Fuser protection cover
3	Output bin
4	Upper cover
5	Fuser component
6	Left cover
7	Front door component
8	Feeder tray
9	Control panel
10	Laser
11	Pickup roller
12	Disengaging gear component
13	Transfer roller
14	Left cover
15	Scan support rod
16	Rear cover



2 Paper feeder system

The picture of Spare parts	The name of Spare parts	Faulty Phenomenon
	Pick-up Assembly 301022060001	<ul style="list-style-type: none"> ● Feed jam, paper light indicate red blinking ● The monitor is shown feed jam
	Separator Pad 301022062001	<ul style="list-style-type: none"> ● Multipage feed ● Feed jam, paper light indicate red blinking ● The monitor is shown feed jam ● Paper jam after multipage feed
	Paper Feed Clutch 301022064001	<ul style="list-style-type: none"> ● Feed jam ● Paper jam at the paper-feeding slot
	Paper Sensor Assembly 301022069001	<ul style="list-style-type: none"> ● Feed jam ● Paper jam at the paper-feeding slot ● Paper jam in the middle ● Paper jam after feeding the first blank paper
	Main Motor 301022057001	<ul style="list-style-type: none"> ● The gear is not rotating after power on. ● Paper feeding jam meanwhile by the roar ● Internal error 000





3 Control Component

The picture of Spare parts	The name of Spare parts	Faulty Phenomenon
	<p>Data Board</p> <p>M6500 301022136001</p> <p>M6550 301022140001</p> <p>M6600 301022156001</p> <p>M6507 301022152001</p>	<ul style="list-style-type: none"> ● USB connection is not recognized ● Toner is not recognized. ● Printing with gibberish ● Printing with blank paper ● Printer is not warming up ● No power(no indicator lights) ● The button on control panel is malfunction. ● Initialized or warming up all the time ● Communication error 22-27 ● The internal error of scanning 11-14
	<p>Data Board</p> <p>M6550N 301022139001</p> <p>M6600N 301022154001</p>	<ul style="list-style-type: none"> ● USB connection is not recognized ● Internet connection is abnormal. ● Toner is not recognized. ● Printing with gibberish ● Printing with blank paper ● Printer is not warming up ● No power(no indicator lights) ● The button on control panel is malfunction. ● Initialized or warming up all the time ● Communication error 22-27 ● The internal error of scanning 11-14







	<p>Data Board</p> <p>M6506NW 301022155001</p> <p>M6550NW 301022138001</p> <p>M6600NW 301022155001</p>	<ul style="list-style-type: none"> ● USB connection is not recognized ● WIFI connection is abnormal. ● wire network connection is abnormal ● Toner is not recognized. ● Printing with gibberish ● Printing with blank paper ● No power(no indicator lights) ● The button on control panel is malfunction. ● Initialized or warming up all the time ● Communication error 22-27 ● The internal error of scanning 11-14
	<p>Data Board</p> <p>M6500W 301022137001</p> <p>M6550W 301022141001</p> <p>M6600W 301022157001</p> <p>M6507W 301022153001</p>	<ul style="list-style-type: none"> ● USB connection is not recognized ● WIFI connection is abnormal. ● Toner is not recognized. ● Printing with gibberish ● Printing with blank paper ● No power(no indicator lights) ● The button on control panel is malfunction. ● Initialized or warming up all the time ● Communication error 22-27 ● The internal error of scanning 11-14
	<p>Engine Board</p>	<ul style="list-style-type: none"> ● Internal error 000 ● Internal error 001-002 ● Internal error 003-014 ● Fuser unit adhesion



	<p>Control Board</p>	<ul style="list-style-type: none"> ● Blurred screen and not shown anything. ● The button is malfunction.
	<p>Fax Board 301022159001</p>	<ul style="list-style-type: none"> ● The fax function is abnormal ● Telephone communication is abnormal.
	<p>High-Voltage Power Supply Board 301022142001 (220 V) 301022143001 (110V)</p>	<ul style="list-style-type: none"> ● Internal error 003-014 ● No power ● Printing with all blank or all black ● It shown "output bin is not closed." ● Fuser unit adhesion ● Toner is not recognized.

4 Imaging Component

The picture of Spare parts	The name of Spare parts	Faulty Phenomenon
	Laser Scanning Unit 301022055001	<ul style="list-style-type: none"> ● Internal error 001-002 ● Printing with all blank ● Printing with blank lines
	Transfer Roller 301022066001	<ul style="list-style-type: none"> ● Printing pale at one side ● Printing pale overall
	Fuser Unit 301022088001(110v) 301022090001(220v)	<ul style="list-style-type: none"> ● Internal error003-014 ● Paper jam ● Abnormal noise
	Fuser Unit Drive Gear 301022073001	<ul style="list-style-type: none"> ● Paper jam ● Abnormal noise

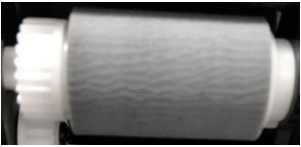
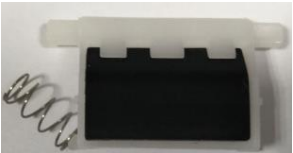
5 Scanning Component

The picture of Spare parts	The name of Spare parts	Faulty Phenomenon
	Scanning USB cable 301022145001	<ul style="list-style-type: none"> ● Internal scanning error 11-14 ● Both of Scanning and copping's effect is abnormal.
	Scanning Head	<ul style="list-style-type: none"> ● Internal scanning error 11-14 ● Both of Scanning and copping's effect is abnormal.
	Scanning Motor	<ul style="list-style-type: none"> ● Internal error 11-13 ● Unknown Err 064 failure ● The scanning sound is abnormal
	The reset sensor of scanning	<ul style="list-style-type: none"> ● Internal error 11-14
	Vitreous platform	<ul style="list-style-type: none"> ● Internal error 11-13 ● Vitreous platform is broken
	Vitreous platform	<ul style="list-style-type: none"> ● Internal error 11-13 ● Vitreous platform is broken
	Document feeder pick up roller	<ul style="list-style-type: none"> ● Feed jam in document feeder ● Paper jam in document feeder(it shown "ADF paper jam")
	Document feeder Separator Pad	<ul style="list-style-type: none"> ● Feed jam in document feeder ● Paper jam in document feeder(it shown "ADF paper jam")

	Document feeder sensor	<ul style="list-style-type: none"> ● Feed jam in document feeder ● Paper jam in document feeder(it shown “ADF paper jam”) ● It shown “ADF upper cover is not closed”
	Document feeder motor	<ul style="list-style-type: none"> ● Feed jam in document feeder ● Paper jam in document feeder(it shown “ADF paper jam”) ● Abnormal noise when feeding paper

6 Other Spare Parts

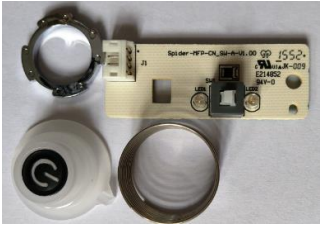
The picture of Spare parts	The name of Spare parts	Faulty Phenomenon
	OPC Drive Gear 301022071001	<ul style="list-style-type: none"> ● Abrasion ● Jumping the gear
	Switch button assemble	<ul style="list-style-type: none"> ● Switch failure ● Switch no power